

Let Us

Show you our bar markings

Reinforcing Bar Grade Identification

Reinforcing Bars AS/NZS 4671: GRADE 500E and 300E

Product identification is critical to ensure that the materials meet AS/NZS 4671 Australian/New Zealand Standard, Steel for the reinforcement of Concrete.

Marking requirements of steels as per AS/NZS 4671

-> Requirements

Reinforcing steels shall be identified by either an alphanumeric marking system on the surface of the bar that identifies strength grade and ductility class or by a series of surface features on products at intervals of not greater than 1.5 m.

-> Identification of Grade

Deformed grade 500E (excluding threaded bar) identified by two rows of transverse ribs reversing in opposite sides of the bar and have on one or two sides, two missed deformations adjacent to two additional longitudinal bars joining two consecutive transverse ribs, as shown in Figure A.

Deformed grade 300E identified by two rows of transverse ribs reversing in direction on opposite sides of the bar and having on one or two sides, two longitudinal marks joining two consecutive transverse ribs, as shown in Figure B.

-> Identification of the steel producer

All reinforcing steel shall carry unique marks enabling the steel producer to be identified. Details of the steel producer's identification marking shall be made available on request.

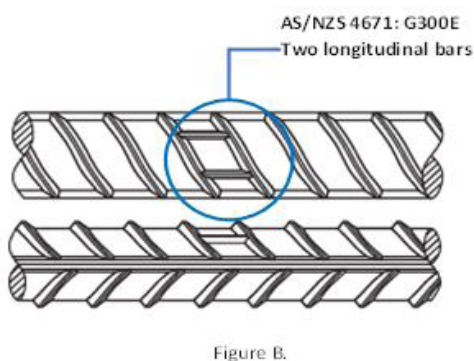
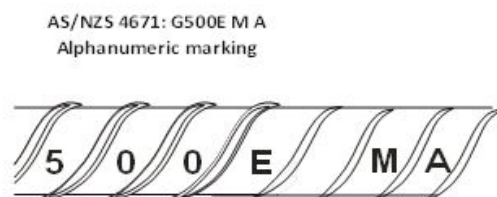
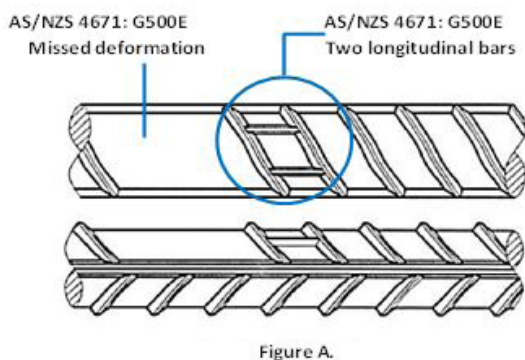









Steel Mill Identification



Below are the bar markings for the most commonly available products in New Zealand as sourced and supplied by Summit Steel & Wire.

The key importance when identifying Grade is to look for the rolled-in compliance markings. These will be either an alphanumeric marking or Series of surface features – as illustrated in the examples below.

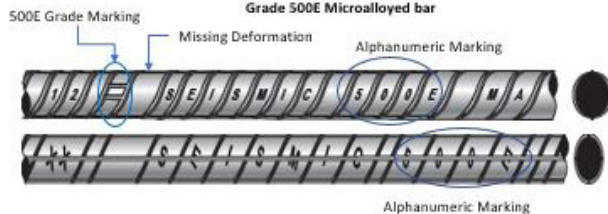
Grade 500E

 <p>AMSTEEL MILLS Amsteel Klang, Selangor, Malaysia Certificate Number: 60902*</p>	<p>Grade 500E Microalloyed bar</p> 
 <p>CELSA GROUP Celsa Barcelona, Spain Certificate Number: 170703*</p>	<p>Grade 500E Microalloyed bar</p>  <p>Start:0 Country code:Spain:7 Producer code:5 ← Celsa Mill Mark</p>
 <p>InfraBuild InfraBuild Laverton, Vic, Australia Certificate Number:31102*</p>	<p>Grade 500E Microalloyed bar and coil</p>  <p>Laverton Straight Bar Marking Laverton Coil Marking</p>
 <p>Kroman KROMAN Darcia, Turkey Certificate Number: 170703*</p>	<p>Grade 500E Microalloyed bar</p> 
 <p>PACIFIC STEEL CERTAIN STRENGTH Pacific Steel Otahuhu, Auckland, NZ Certificate Number: 40503*</p>	<p>Grade 500E Microalloyed bar</p>  <p>Alphanumeric Marking</p>

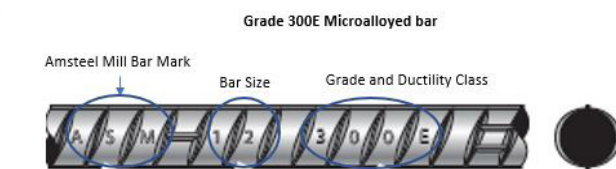
Grade 300E

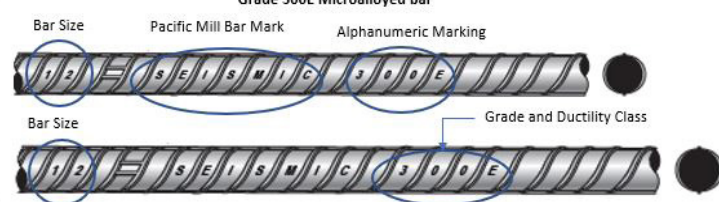
 <p>AMSTEEL MILLS Amsteel Klang, Selangor, Malaysia Certificate Number: 60902*</p>	<p>Grade 300E Microalloyed bar</p> 
 <p>PACIFIC STEEL CERTAIN STRENGTH Pacific Steel Otahuhu, Auckland, NZ Certificate Number: 40503*</p>	<p>Grade 300E Microalloyed bar</p>  <p>Grade and Ductility Class</p>

*Certificate numbers refer to those of the Australian Certification Authority for Reinforcing and Structural Steels (ACRS) which can be found at www.steelcertification.com

Jan 2022/Reinforcing Bar Identification